

1 2 3 4 5 6

A

B

C

D

A

B

C

D

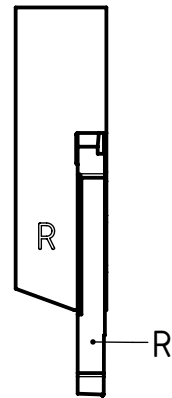
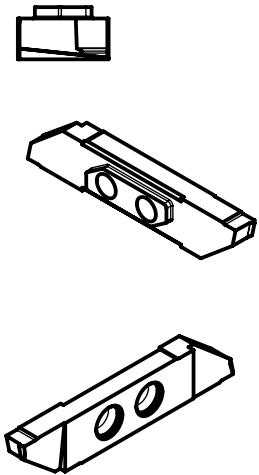
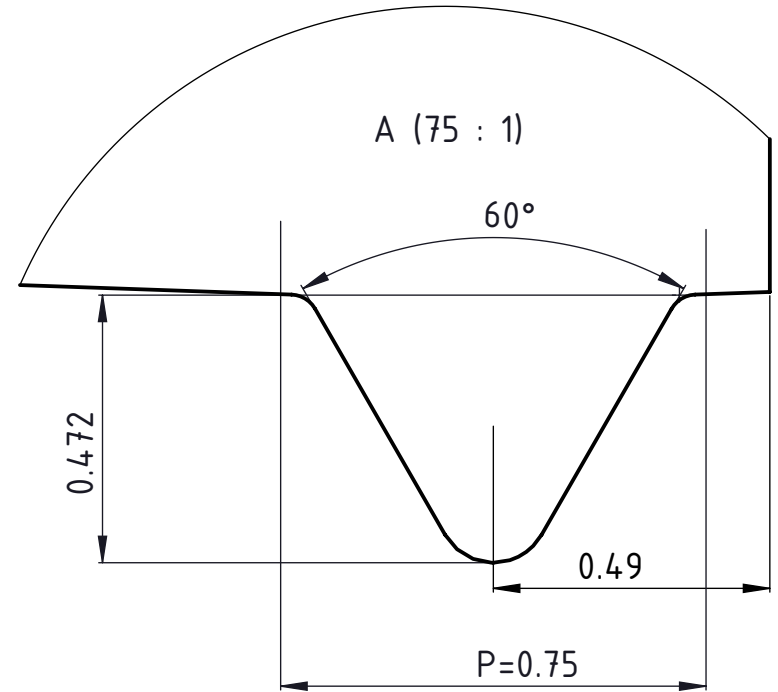
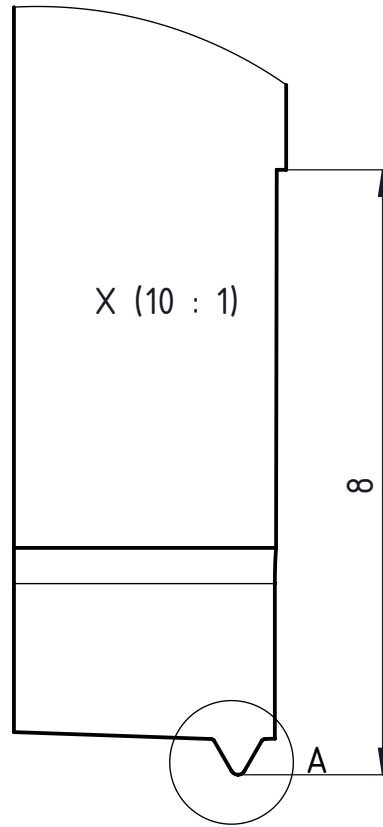
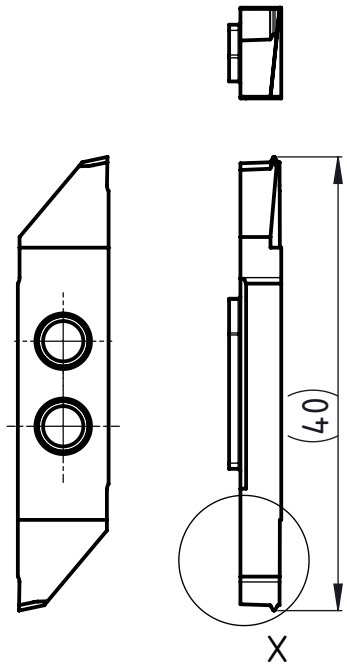

Rechte Ausführung
Execution droite
Right execution



Freigegeben von am
C.Fabozzi am 03.08.2017
erstellt von am
C.Fabozzi am 03.08.2017

Beschreibung
Multidec CUT-Wendplatte
Artikel Bezeichnung
3006 -0.75-60 VP-S R

Zeichnungsnummer
CUT-857-17

