

1 2 3 4 5 6

A

B

C

D

A4-Kunde V7

A

B

C

D

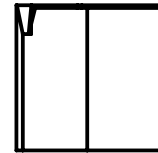
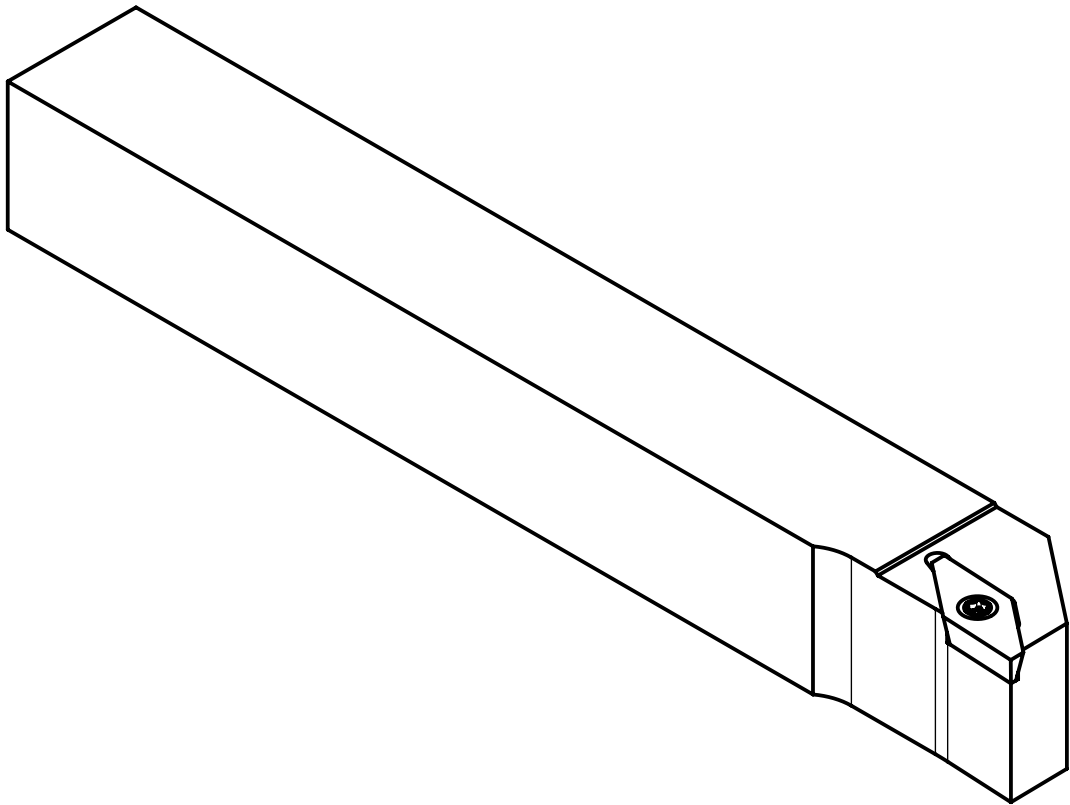

16

16

0

104

125

93°

VP..1003..

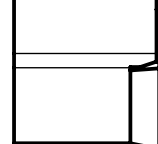
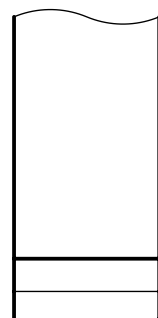
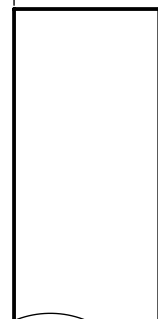
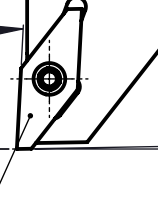
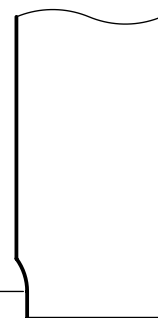
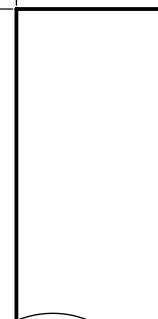

Freigegeben von am

T.Weilenmann am 08.01.2019

erstellt von am

M. Schmitz am 12.12.2014

Beschreibung

Multidec-Top Halter

Artikel Bezeichnung

SVJPL 1616 K10 V

**UTILIS**<sup>®</sup>

*Tooling for High Technology*

Zeichnungsnummer

ISO-141-11



A4

Index

B