

1 2 3 4 5 6

A

B

C

D

A4-Kunde V7

A

B

C

D

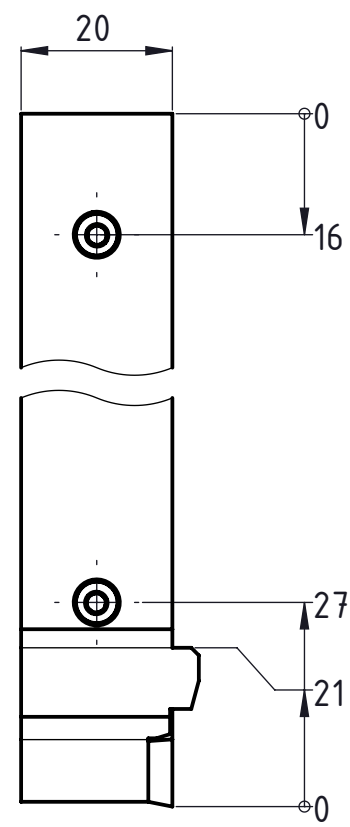
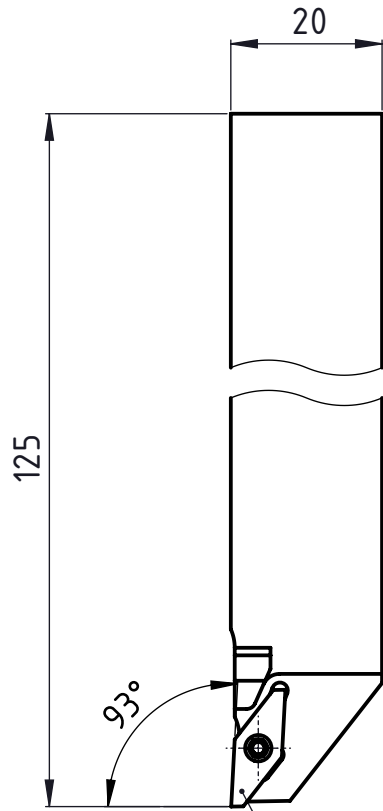
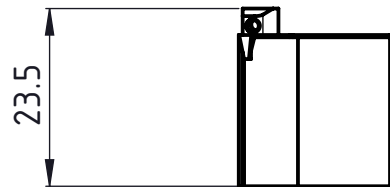
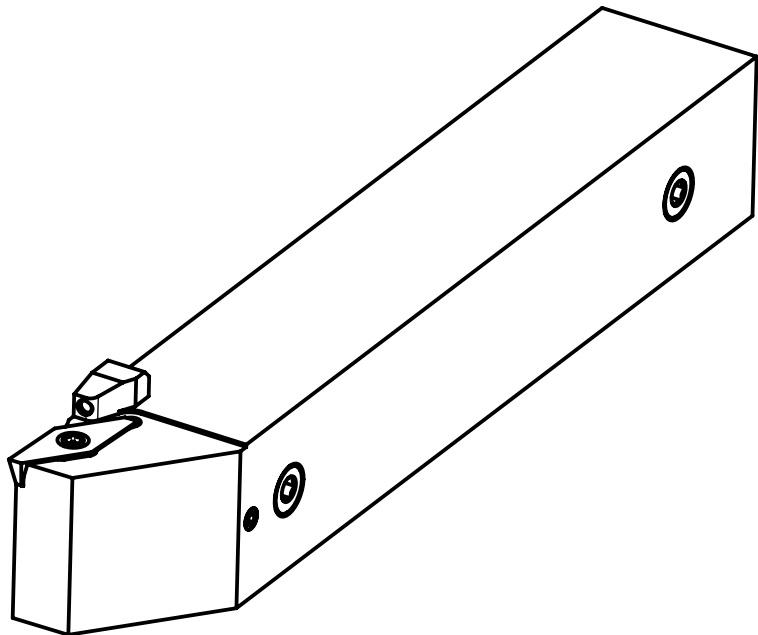

Freigegeben von am
T.Weilenmann am 23.10.2018
 erstellt von am
C.Fabozzi am 18.03.2014

Beschreibung
Multidec-Top Halter
 Artikel Bezeichnung
SVJPL 2020 K10 V IC

UTILIS[®]
Tooling for High Technology
 Zeichnungsnummer
ISO-157-15

A4
Index
C