

1 2 3 4 5 6

A

B

C

D

A

B

C

D

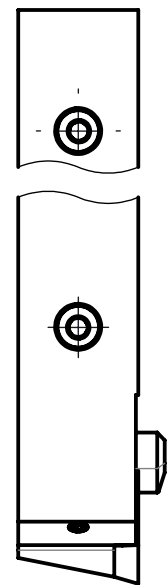
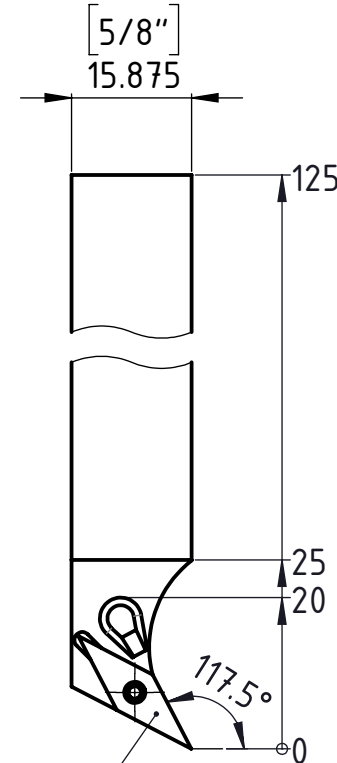
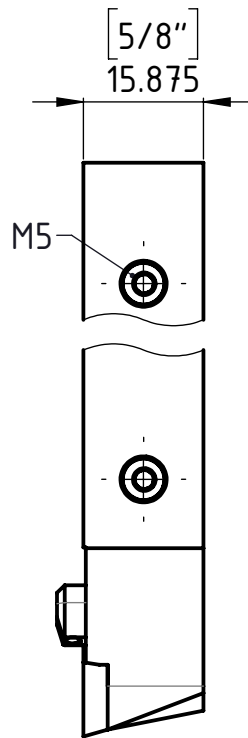
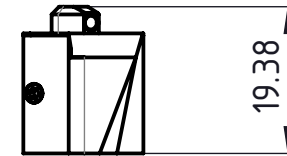
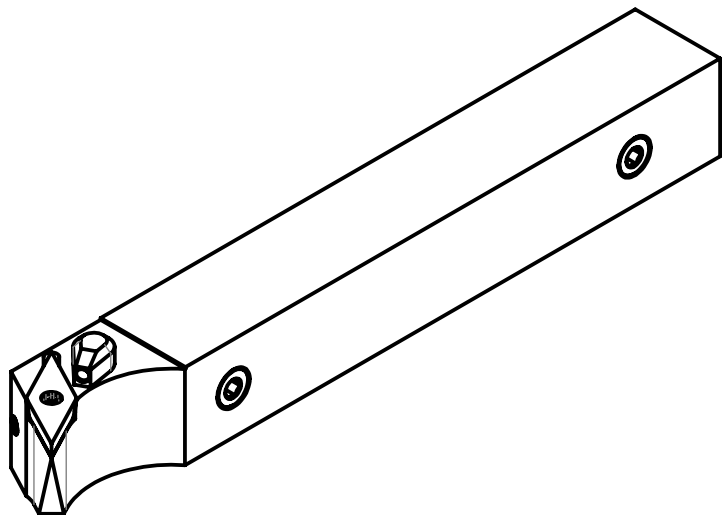

VC..1103..

G1/8"

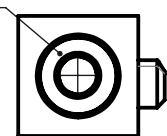

Beschreibung
Multidec-ISO Halter

Artikel Bezeichnung
SVPCR 5/8" K11 U IC

Zeichnungsnummer
ISO-171-02-11

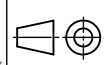

Index
A