

1 2 3 4 5 6

A

A

B

B

C

C

D

D

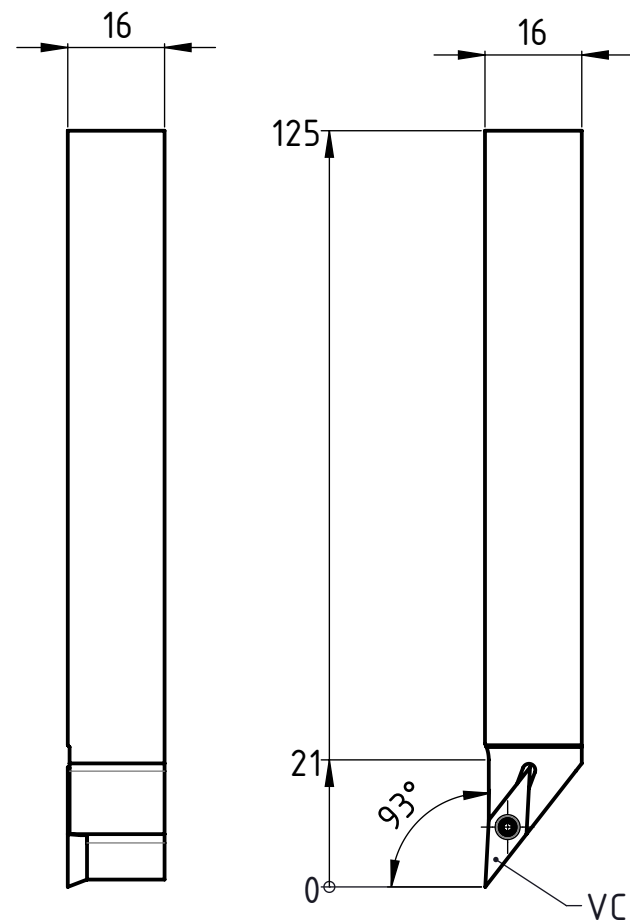
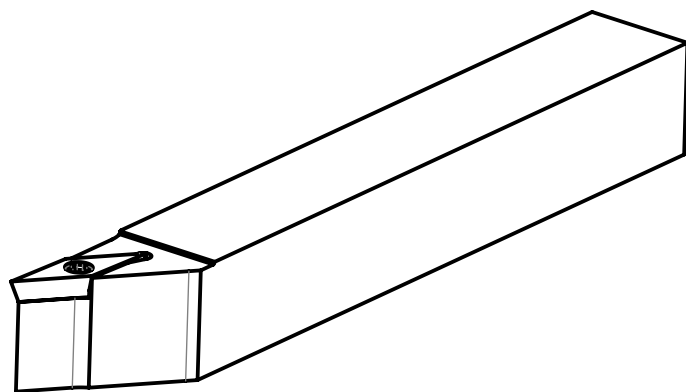

Beschreibung
Multidec-ISO Halter

Artikel Bezeichnung
SVJCL 1616 K11 U

Zeichnungsnummer
ISO-177-14



Index
A