

A

B

C

D

A

B

C

D

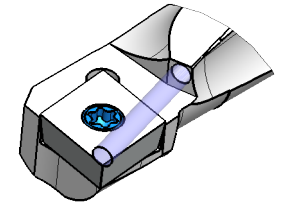
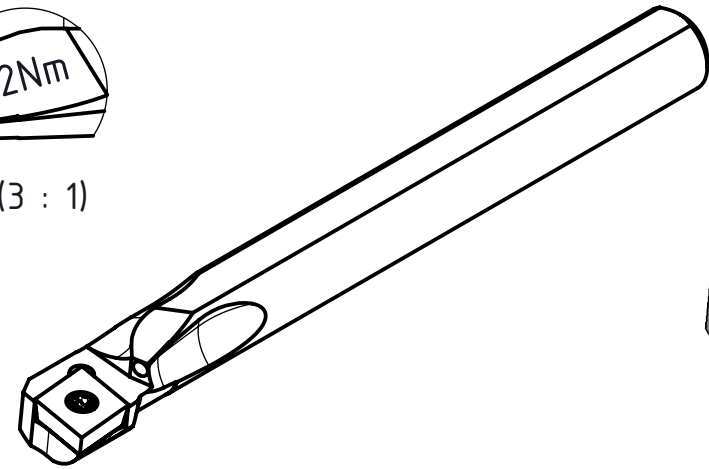
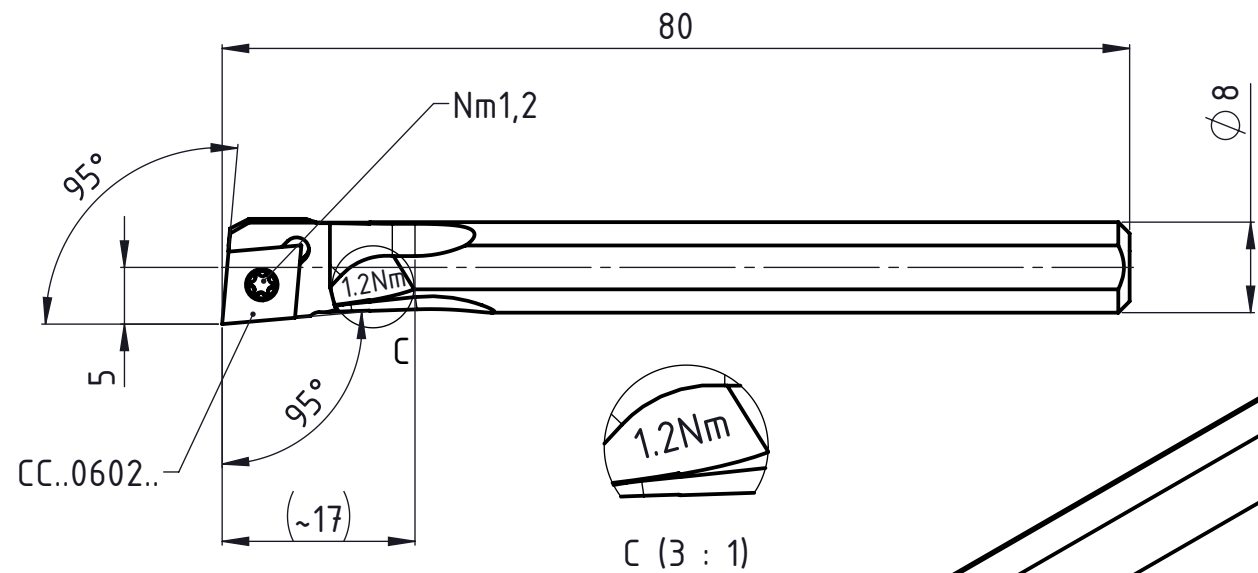
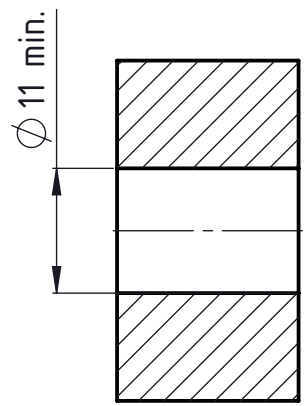
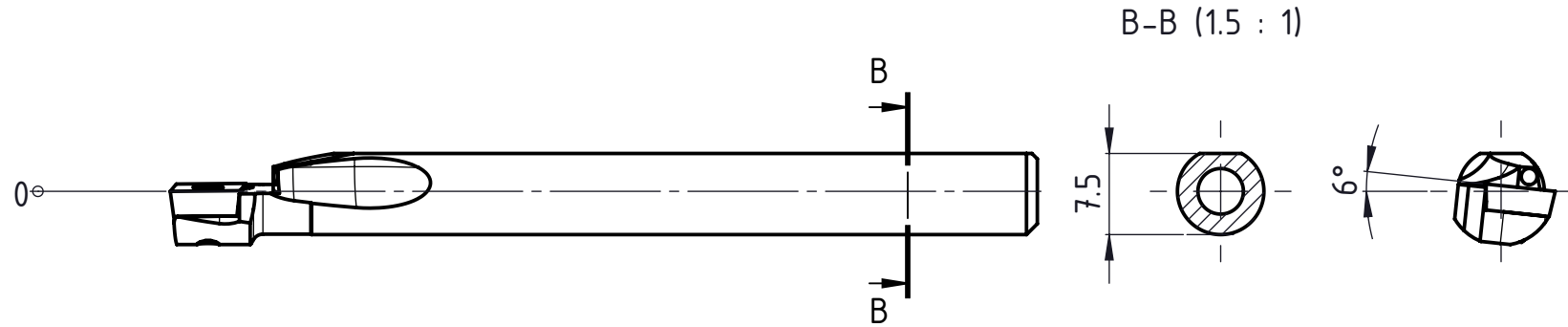

Rechte Ausführung
Exécution droite
Right execution

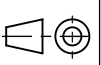
Beschreibung multidec ISO Bohrstange	Artikel Bezeichnung A08F SCLCR 06	Zeichnungsnummer ISO-365-2-1-1	 Tooling for High Technology	 Index -
---	--------------------------------------	-----------------------------------	---	--