

1 2 3 4 5 6

A

B

C

D A4-Kunde-V5

A

B

C

D

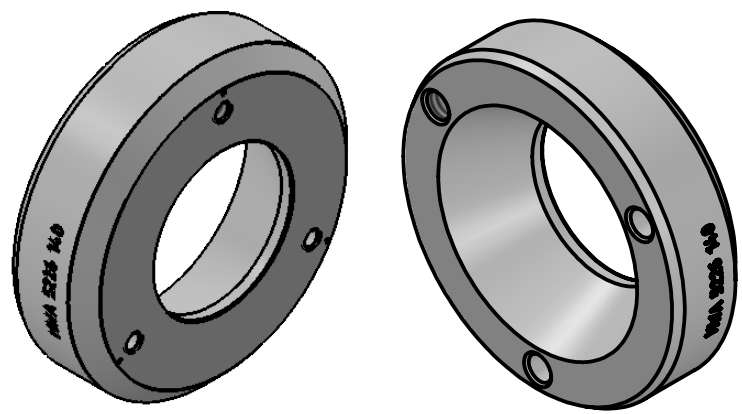
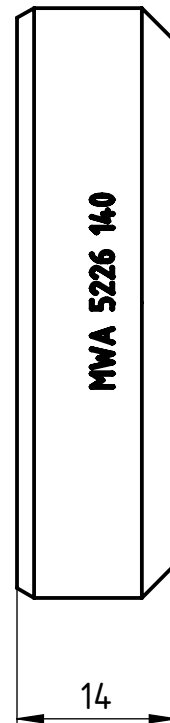
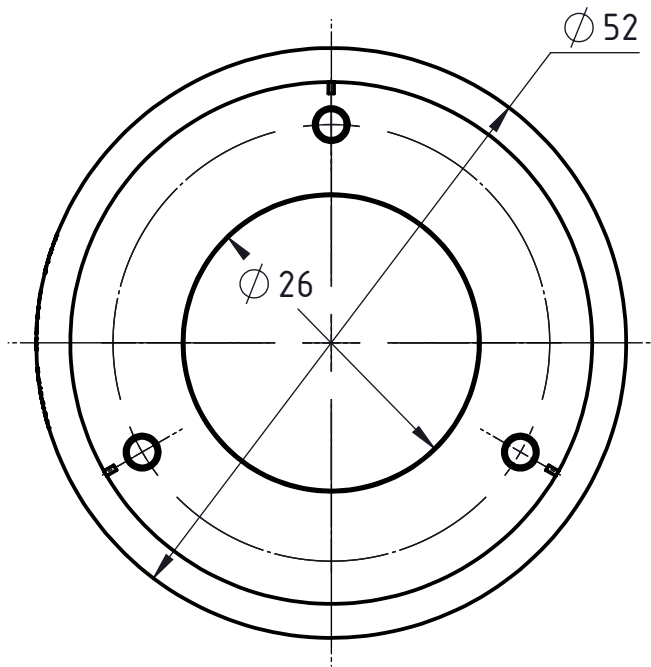

Freigegeben von am
0. Bojic am 20.10.2014

erstellt von am
0. Bojic am 20.10.2014

Beschreibung
Multidec® Gewindewirbeladapter

Artikel Bezeichnung
MWA 5226 140

Artikel Nr.
119427

Zeichnungsnummer
MWA-26-02

Index
-