

1 2 3 4 5 6

A

B

C

D A4-Kunde-V5

A

B

C

D

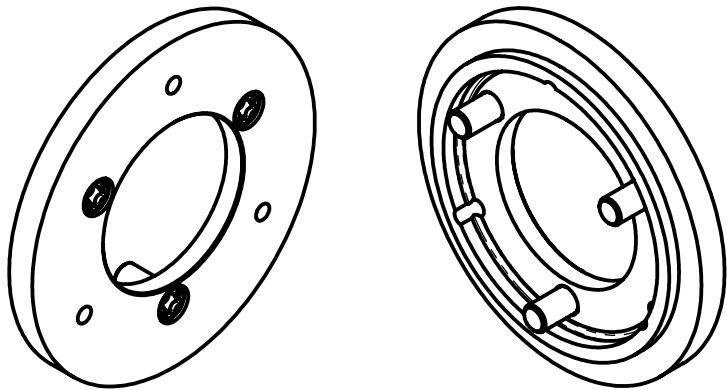
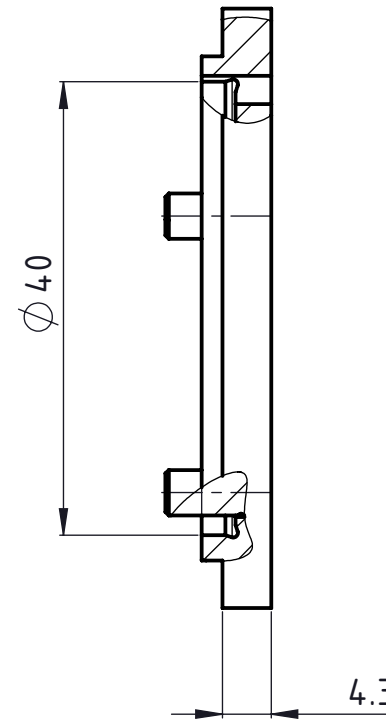
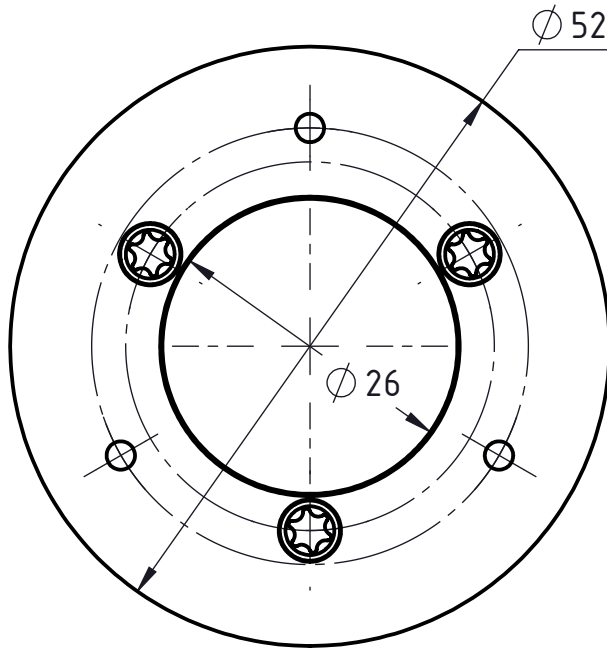

UTILIS
Tooling for High Technology

Freigegeben von am

O. Bojic am 23.05.2017

erstellt von am

E. Rahimi am 23.05.2017

Beschreibung

Multidec®Gewindewirbeladapter

Artikel Bezeichnung

MWA 402653 043

Artikel Nr.

119035

Zeichnungsnummer

MWA-54-02

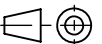

Index

-